

## Specifications

Format	System	Compact disc digital audio system
	Laser	Semiconductor laser
Audio	Frequency response	20 Hz to 20 kHz, $\pm 3$ dB
	PHONE output level (32 $\Omega$ , 1kHz)	7 mW + 7 mW
	Line output/impedance	0.4 Vrms/22 k $\Omega$
Power supply	External DC supply (AC-45060A)	DC 4.5 V
	Commercially-available alkaline batteries (LR03) x 2 or 4	1.5V x 2 (or 4)
	Rechargeable batteries (NB-3A70) x 2 or 4	1.2V x 2 (or 4)
Battery life (Fully charge)		

	CD-DA	MP3
Commercially-available alkaline batteries x 2	Approx. 4.5 Hours	Approx. 9 Hours
Commercially-available alkaline batteries x 4	Approx. 11.5 Hours	Approx. 20 Hours
Rechargeable batteries x 2	Approx. 3.5 Hours	Approx. 6 Hours
Rechargeable batteries x 2 and Commercially-available alkaline batteries x 2	Approx. 8 Hours	Approx. 15 Hours

- Available time of operation when ASP is ON.
- At 0.1mW+0.1mW output (32 $\Omega$  load).
- Standard value during continuous use/charging in an temperature of 20.
- Time of use may vary depending on battery maker, battery type, use environment, and temperature.
- The unit may not operate normally if manganese batteries are used.

Dimensions (W x H x D) ..... 138 mm x 21.5 mm x 138 mm (5-7/16" x 7/8" x 5-7/16")  
 Weight (net) ..... 185 g (6.5 oz)

Note:  
 KENWOOD follows a policy of continuous advancements in development. For this reason specifications may be changed without notice.

### Accessories

For Europe : AC adaptor(1), Remote control (1), Headphones(1)  
 For other countries : Remote control (1), Headphones(1)

### Separately sold option part

Rechargeable Nickel Metal Hydride Battery ..... NB-3A70

## KENWOOD

### For your records

Record the serial number, found on the back of the unit, in the spaces designated on the warranty card, and in the space provided below. Refer to the model and serial numbers whenever you call upon your dealer for information or service on this product.

Model \_\_\_\_\_ Serial Number \_\_\_\_\_

# KENWOOD

PORTABLE CD PLAYER

## DPC-X447MP

### INSTRUCTION MANUAL

KENWOOD CORPORATION

#### CAUTION: (Except for Europe)

- THIS UNIT IS DESIGNED ONLY FOR LR03 ALKALINE BATTERY OPERATION AND NO RECHARGEABLE BATTERIES AND AC ADAPTORS SHOULD BE USED.
- Common accessories available in general electrical stores may cause damage and fire to your unit, in such event the Kenwood Product Liabilities will be exempted.

### Unpacking

Unpack the unit carefully and make sure that all the accessories are present. If any accessories are missing, or if the unit is damaged or fails to operate, notify your dealer immediately. If the unit was shipped to you directly, notify your shipper immediately. Kenwood recommends that you retain the original carton and packing materials in case you need to move or ship the unit in the future.

Keep this manual handy for future reference.



B60-5514-28 02 (E, Y) AP 0402

## Maintenance

### Care of lens

When the lens in the pick-up gets dirty, malfunctions including the impossibility of playback may occur. The lens should be cleaned using a commercially available camera lens blower, etc. Do not touch the lens to prevent damaging the mechanism. Also do not use a lens cleaner or disc cleaner product.

### Care of main unit

When the unit gets dirty, clean with a soft, dry cloth. If the unit is stained seriously, a moistened cloth can be used. Do not use thinner, benzine, alcohol, etc. for these agents may cause discoloration.

### Cleaning the plug

Wipe the headphone plug with a soft cloth to keep it clean.  
 A dirty plug may cause noise or malfunction.

### Caution on disc used

#### Usable discs:

This unit is capable of playing back the Audio CD discs, CD-R/CD-RW (CD-DA, MP3/WMA) discs and discs carrying the  marking. Other discs cannot be played. 8 cm single CDs can be played as they are; do not use a commercially-available single CD adapter.

- Certain CD-R/CD-RW (CD-DA, MP3/WMA) discs may not be played due to recording conditions of the discs.

#### Handling:

Hold compact discs so that you do not touch the playing surface.  
 Do not attach paper or tape to either the playing side or the label side of compact discs.

#### Never play a cracked or warped disc:

During playback, the disc rotates at high speed in the player. Therefore, to avoid danger, never use a cracked or deformed disc or a disc repaired with tape or adhesive agent.

#### Cleaning

If fingerprints or foreign matter become attached to the disc, lightly wipe the disc with a soft cotton cloth (or similar) from the center of the disc outwards in a radial manner.

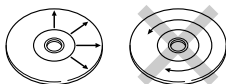

### Storage

When a disc is not to be played for a long period of time, remove it from the CD player and store it in its case.

### Caution on condensation

Condensation (of dew) may occur inside the unit when there is a great difference in temperature between this unit and the outside.

This unit may not function properly if condensation occurs. In this case, leave the unit for a few hours and restart the operation after the condensation has dried up.

Be specially cautious against condensation in the following circumstances:  
 When this unit is carried from one place to another across a large difference in temperature, when the humidity in the room where this unit is installed increases, etc.

## Safety precautions

**⚠ Caution:** Read this page carefully to ensure safe operation.

**WARNING :** TO PREVENT FIRE OR ELECTRIC SHOCK, DO NOT EXPOSE THIS APPLIANCE TO RAIN OR MOISTURE.

## IMPORTANT SAFEGUARDS

Please read all of the safety and operating instructions before operating this unit. For best results, follow all warnings placed on the unit and adhere to the operating and use instructions. These safety and operating instructions should be retained for future reference.

- 1. Power sources** — The appliance should be connected to a power supply only of the type described in the instruction manual or as marked on the appliance.
- 2. Power-cord protection** — Power-supply cords should be routed so that they are not likely to be walked on or pinched by items placed upon or against them, pay particular attention to cords at plugs, convenience receptacles, and the point where they exit from the appliance.
- 3. Enclosure removal** — Never remove the enclosure. If the internal parts are touched accidentally, a serious electric shock might occur.
- 4. Drop** — Do not drop the appliance or apply strong shock to it. (Damage due to dropping the appliance is not covered by the warranty.)
- 5. Ventilation** — Avoid hindering the ventilation of the appliance by covering it with a cloth, etc.
- 6. Abnormal smell** — If an abnormal smell or smoke is detected, immediately turn the power OFF and pull out the power cord. Contact your dealer or nearest service center.
- 7. Heat** — Avoid placing the appliance under direct sunlight or near a source of heat such as heating equipment. Particularly, never leave it in an automobile or on the dashboard.
- 8. Temperature** — The appliance may not function properly if used at extremely low, or freezing temperatures. The ideal ambient temperature is above +5°C (41°F).
- 9. Water and moisture** — The appliance shall not be exposed to dripping and splashing - for example, near a bathtub, washbowl, kitchen sink, laundry tub, in a wet basement, or near a swimming pool, etc.
- 10. Dust and moisture** — Avoid places where is dusty or where the humidity is high.
- 11. Vibrations** — Avoid placing the appliance on an unstable place such as a shelf or in a place subject to vibrations.
- 12. Magnetic fields** — Keep the appliance away from sources of magnetic fields such as TV sets, speaker systems, radios, motorized toys or magnetized objects.
- 13. Cleaning** — Unplug this appliance from the wall outlet before cleaning. Do not use volatile solvents such as alcohol, paint thinner, gasoline, or benzene, etc. to clean the cabinet. Use a clean dry cloth.
- 14. Nonuse periods** — The power cord of the appliance should be unplugged from the outlet when left unused for a long period of time.
- 15. Damage requiring service** — The appliance should be serviced by qualified service personnel when:
  - A.** The power-supply cord or the plug has been damaged.
  - B.** Objects have fallen, or liquid has been spilled into the appliance.
  - C.** The appliance has been exposed to rain or water.
  - D.** The appliance does not appear to operate normally by following the instruction manual. Adjust only those controls that are covered by the instruction manual as an improper adjustment of other controls may result in damage and will often require extensive work by a qualified technician to restore the appliance to its normal operation.
  - E.** The appliance has been dropped, or the enclosure damaged.
  - F.** The appliance exhibits a marked change in performance.
- 16. Servicing** — The user should not attempt to service the appliance beyond that described in the instruction manual. All other servicing should be referred to qualified service personnel.
- 17. CAUTION** — TO PREVENT ELECTRIC SHOCK DO NOT USE THE AC PLUG WITH AN EXTENSION CORD, RECEPTACLE OR OTHER OUTLET UNLESS THE BLADES CAN BE FULLY INSERTED TO PREVENT BLADE EXPOSURE.

### The marking of products using lasers (For countries other than U.S.A., U.S.-Military and Canada)

CLASS 1 LASER PRODUCT  
LASER KLASSE 1  
APPAREIL A LASER DE CLASSE 1  
LUOKAN 1 LASERLAITE  
KLASS 1 LASERAPPARAT

The marking this product has been classified as Class 1.  
It means that there is no danger of hazardous radiation outside the product.  
Location: Back panel

## Media that can be played back with this equipment

This unit is capable of playing back Audio CD and CD-R/RW (CD-DA) discs. This unit is capable of playing back the music files recorded in the MP3/WMA audio compression format on CD-R/RW discs. This unit may also be incapable of playing certain discs depending on their properties, recording conditions, etc.

■ **Usable media:**  
CD-ROM (CD-R/CD-RW)

■ **Usable formats:**  
ISO 9660 Level 1  
Joliet

■ **Files that can be played back:**  
MP3 files and WMA files (Version 7.0/8.0)

- This unit can display the ID3 Tag information recorded in the disc.
- Please set up the transfer bit rate setting for the compression software when compressing MP3 and WMA files as follows:

**MP3 Files:**  
128kbps recommended

**WMA Files:**  
64kbps recommended

- This unit is compatible with 32kHz, 44.1kHz (recommended) and 48kHz sampling frequencies.
- This unit can play back only the closed sessions. This unit is compatible with multi-session discs.
- The maximum numbers of folders and files in the disc played with this unit are respectively limited to 200 folders and 500 files.
- The maximum number of files per folder is limited to 99 files.
- There are cases where it is not possible to save folders in the desired sequence depending on the software being used.
- If the MP3 or WMA extension logs are added to any files other than ".MP3" and ".WMA" files, the equipment will assume that they can be played back, and this will produce loud noises in the headphones, resulting in damage of adverse effects.

## Part names

### Unit

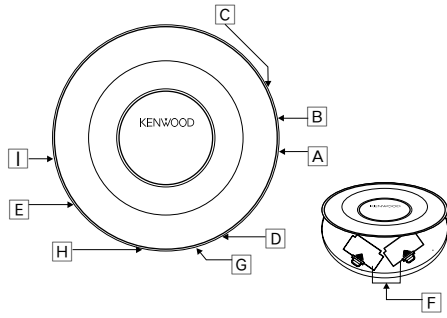

- A **VOL** (Volume) knob
- B **LINE OUT** jack
- C **PHONE** (Phones/Remote) jacks
- D **■** (Stop/Off) key
- E **HOLD** switch
- F Batteries case
- G **▶||** (Play/Pause) key
- H **OPEN** switch  
(Slide to open top cover)
- I **DC IN 4.5V** (External power) jack

### Remote control

The keys on the remote control unit with the same names as on the main unit have the same function as the keys on the main unit.

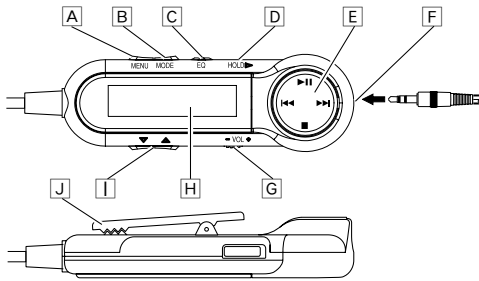

- A **MENU** key
- B **MODE** key
- C **EQ** key
- D **HOLD** switch
- E **▶||** (Play/Pause) key / **◀▶** keys  
■ (Stop/Off) key
- F Phones jack
- G **VOL** (Volume) knob
- H Display
- I **▼▲** keys
- J Clip

### Display (Remote control)

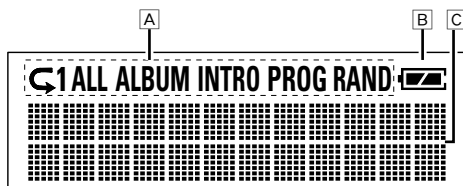

- A Play mode indicator/ Program mode indicator
- B Battery duration indicator
- C Character information display

## Power sources

### Using the AC adaptor (For Europe) ①

**CAUTION**  
Use the enclosed AC adaptor (AC-45060A) for this product.

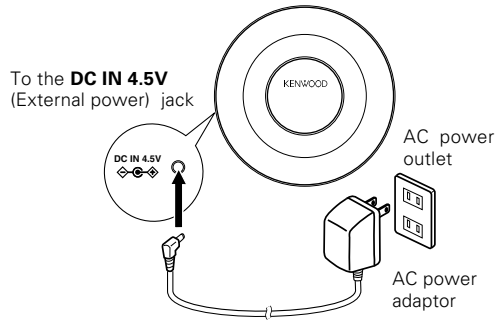

### Rechargeable battery operation

#### (For Europe) ②

**Note:**  
Rechargeable batteries are not provided with this unit. Always use the separately sold rechargeable batteries NB-3A70. Rechargeable battery models other than the NB-3A70 may be unable to be recharged.

#### ■ Loading the batteries

- ① Open the battery cover.
- ② Insert 2 or 4 rechargeable batteries and close the cover.

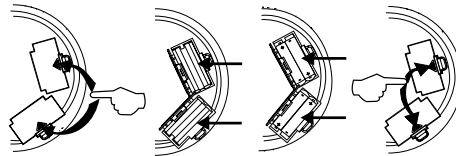

- Make sure the positive (+) and negative (-) poles are properly aligned.
- When using two batteries, these can be loaded in either battery case.
- During battery charging or use of the unit, the battery may become warm. This is normal and does not indicate a malfunction.

#### ■ Charging the rechargeable batteries

- ① Plug in the AC adaptor.
- ② Press and hold the **■** key until "Charge" appears in the remote control display (3 seconds or more).

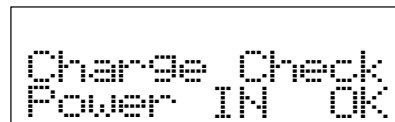

- ③ After the batteries have been charged, remove the AC adaptor.

- When using a rechargeable battery which is new or which has not been used for more than 2 months, the operating period may be shorter than normal. This is due to the properties of the battery and not a malfunction. After recharging, use the battery on the unit until it is exhausted. The original performance of the battery can be recovered by repeating this cycle a few times.
- Make sure to close the top cover of the unit before proceeding to recharging.
- Make sure that no alkaline batteries are loaded in the battery cases before charging the rechargeable batteries.
- Recharging completes in about 10 hours. Do not attempt to recharge the batteries after this period.
- Rechargeable batteries can be recharged. When the playable time per recharge reduces, please newly purchase the optional (NB-3A70) rechargeable batteries.

### When operating the unit with alkaline batteries ③

**Note:**  
Alkaline batteries are not provided with this unit.

- ① Open the battery cover.
- ② Insert 2 or 4 alkaline batteries and close the cover.

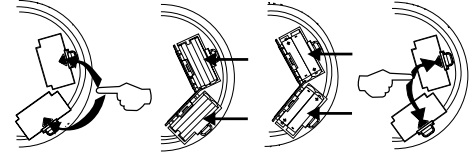

- Make sure the positive (+) and negative (-) poles are properly aligned.
- When using two batteries, these can be loaded in either battery case.
- Use commercially available LR03 batteries. The unit may not operate normally if manganese batteries are used.
- Replace 2 or 4 batteries at the same time.

### When operating the unit with 2 rechargeable batteries and 2 alkaline batteries ④

**CAUTION**  
Do not load one rechargeable and one alkaline batteries together in the same battery case. Otherwise, battery burst or fluid leak may cause a fire, injury or damage to the battery case and its surroundings.

This unit can be operated with 2 rechargeable batteries and 2 alkaline batteries.

- When 4 batteries are used, make sure they are arranged so that batteries of the same type are in line horizontally (see illustration).
- Always use the separately sold rechargeable battery NB-3A70.
- Exchange the same type of batteries at the same time.

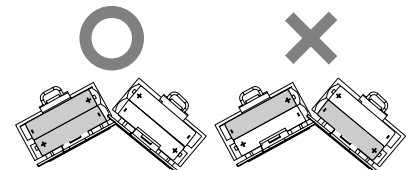

Rechargeable batteries (NB-3A70)

Alkaline batteries

### Battery duration indicator

The duration at which the battery indicator starts to blink is variable depending on the type of battery used.

- **Rechargeable batteries**  
**When the batteries is nearly exhausted:**  
⇒ In a while, the power will be turned off automatically. Then recharge the batteries.

- **Alkaline batteries**  
**When the batteries are half exhausted:**  
⇒ Playback is possible while the indicator is blinking.

Battery duration indicator

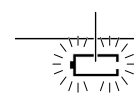

## Playback from the first track ⑤

PHONE (Phones/ Remote) jacks

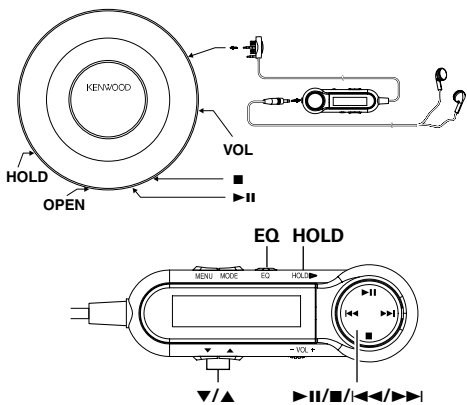

- Slide the **OPEN** switch in the direction of the arrow to open the top cover.
- Insert disc and close the top cover.
  - Insert with labeled side up.
  - Secure the disc by pushing a position near the center hole until it clicks.
  - Close securely by pushing the front center position of the top cover until it clicks.
- Set the **HOLD** switch to off.
  - For the Hold function, read "Hold function".
  - Before any operation, be sure to set the **HOLD** switch to off.
- Press the **▶||** key.
  - The power comes on and playback begins.
  - Certain CD-R/CD-RW (CD-DA, MP3/WMA) discs may not be played due to recording conditions of the discs.

### CD-DA:

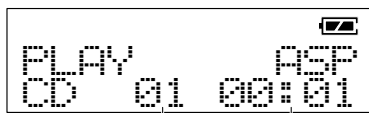

Track number Elapsed time of track being played

### MP3/WMA:

ID3 Tag display

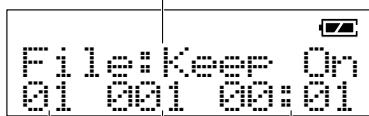

Folder number File number Elapsed time of track being played

- Use the **VOL** knob to adjust the volume.

### To pause playback temporarily

- Press the **▶||** key during playback states.
- Pressing the key again resumes playback.

### To stop playback

- Press the **■** key during playback states.
- The total number of tracks and the total playing time of them will be displayed.

### To turn power off

After stopping playback, press the **■** key again.

#### Auto power-off function

If no operation key has been pressed for 1 minutes while the unit is in the stop mode, the power is turned off automatically to prevent battery power consumption.

### Selecting the folder

(Only MP3/WMA)

Use the **▼** or **▲** key to select the folder.

- Press the **▶||** key starts playback from the first file in the selected folder.

### Skipping tracks

Press the **◀◀** or **▶▶** key.

- When the **▶▶** key is pressed, playback will skip to the start of the subsequent track.
- Each time the key is pressed, playback will skip to the next track.
- When the **◀◀** key is pressed, playback will skip to the start of the track being played back.
- Each time the key is pressed, playback will skip to the previous track.

### Fast forward, fast reverse

Hold the **◀◀** key or **▶▶** key pressed during playback.

- Fast forward is engaged by pressing and holding down key **▶▶** while playback is in progress.
- Fast reverse is engaged by pressing and holding down key **◀◀** while playback is in progress.
- Playback will resume when either key is released.

### Hold function

Slide the **HOLD** switch in the direction of the arrow to switch the HOLD function on.

- When the **HOLD** switch on the unit is switched on, the unit's keys cannot be operated.
- When the **HOLD** switch on the remote control is switched on, the remote control's keys cannot be operated.

### Changing the tone

Press the **EQ** key for the following selections.

- |             |          |
|-------------|----------|
| ① "FLAT"    | ④ "ROCK" |
| ② "CLASSIC" | ⑤ "POP"  |
| ③ "JAZZ"    | ⑥ "BASS" |

## Selecting Play Mode ⑥

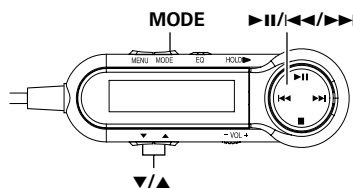

Press the **MODE** key for the following selections. (Press the playback status)

- One-track repeat** ("◁1" lights up)  
The track being played will be played repeatedly.
  - To play the next track repeatedly, press the **◀◀** or **▶▶** key.
- Album repeat** ("◁ALBUM" lights up)  
(Only MP3/WMA)  
All of the tracks in the folder containing the track being played will be played repeatedly.
  - To play the next folder repeatedly, press the **▲** or **▼** key.
- All-track repeat** ("◁ALL" lights up)  
All tracks on the disc will be played repeatedly.
- Intro Scan** ("INTRO" lights up)  
The first 10 seconds of all tracks on the disc will be played in the recorded order.
- Random playback** ("RAND" lights up)  
All tracks on the disc will be played in a random order.
- Normal playback**

- If Intro Scan or Random Playback is selected while playback is in progress, Intro Scan or Random Play operation will commence when the track being played back is over.
- The program of tracks is also valid in Repeat or Intro Scan playback.

## Program playback ⑦

Favorite tracks (max. 64 tracks) can be programmed.

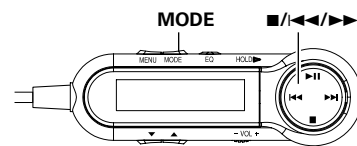

- Press the **MODE** key during stop status.
  - Stop status is engaged when the **■** key is pressed while playback is in progress.
- Use the **◀◀** or **▶▶** key to select the folder, and press the **MODE** key.
  - If the medium being played is a CD, simply select the track to be programmed.

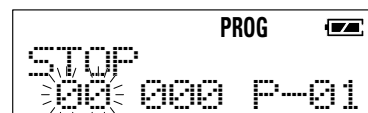

Use the **◀◀** or **▶▶** key to select the file, and press the **MODE** key.



- Repeat step ② to select other folders/files or tracks in the order you want to program them.
  - Up to 64 tracks can be programmed in this unit.
- Press the **▶||** key.

### To clear the programmed contents

Press the **■** key.

- The "PROG" indicator is turned off when the program is cleared. However, the programmed contents are stored.
- Program mode can be canceled when the **■** key is pressed or the top cover is open while stop status is engaged. The programmed contents are cleared.

## Searching for MP3/WMA

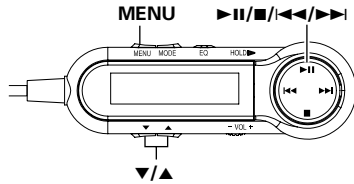

### Searching for folders/files ⑧

1 Press the **MENU** key once.

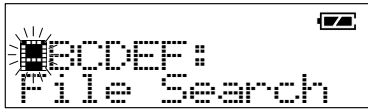

2 Use the **▼** or **▲** key to select the alphanumeric character group.

Use the **◀◀** or **▶▶** key to select the desired character.



- ① "A B C D E F"
- ② "G H I J K L"
- ③ "M N O P Q R"
- ④ "S T U V W X"
- ⑤ "Y Z 0 1 2 3"
- ⑥ "4 5 6 7 8 9"
- ⑦ "\*" → ← ↻ ▶ ■

3 Press the **▶▶** key to enter the selected character for use in search.



- If you made a mistake during entry, press the **■** key.

4 Use the **▲**, **▼** or **◀◀**, **▶▶** key to select "▶", and press the **▶▶** key.

### Selecting folders/files ⑨

1 Press the **MENU** key twice.

2 Use the **◀◀** or **▶▶** key to select the folder selection mode or file selection mode.

**Folder selection mode:**



**File selection mode:**

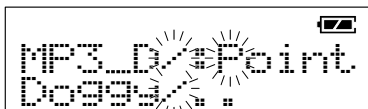

3 Use the **▲** or **▼** key to select the folder or file, and press the **▶▶** key.

## Sound skip guard function (ASP) (CD-DA only) ⑩

**ASP (Anti Skip Protection) :**

When ASP function set to ON, the audio signals of a certain period is stored in memory so that, even when the signal from the optical pickup is interrupted by an external shock, this unit can continue music without interruption.

The ASP function is activated permanently during playback of MP3/WMA files.

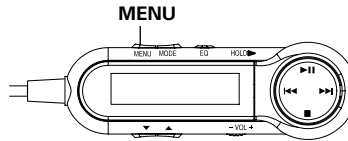

Press the **MENU** key during stop status.

Light at ASP ON

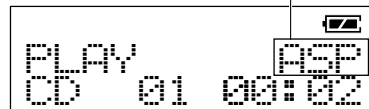

**CD-DA:**

Records approximately 40 seconds of data.

**MP3 file:** (Bit rate 128kbps)

Records approximately 120 seconds of data.

**WMA file:** (Bit rate 64kbps)

Records approximately 480 seconds of data.

- Depending on the extent of the impact, the data in the memory may be used up, so the playback skip protection may momentarily be ineffective.

Ensure that the power of all components is off before connecting the cords.

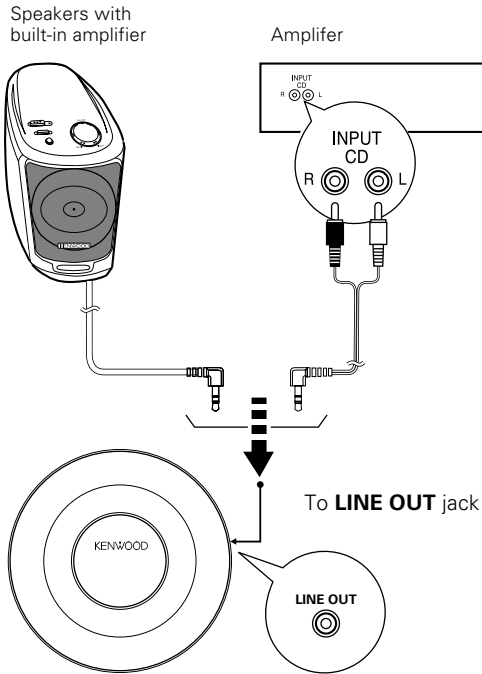

**Note:**

- Adjust the listening volume on the connected audio component.
- The preset equalizer should be set to "FLAT". (The tone should be adjusted only on the connected audio component.)

What seems to be a serious trouble may sometimes be due to a simple mistake. Before calling for service, check the items shown in the following table again. (If you request servicing due to the reasons shown in the table, the service may be charged in some cases.)

**Pressing a key cannot initiate an operation or turn the unit on.**

- The **HOLD** switch of the main unit or remote control is set to ON.
  - ⇒ Set the switch to off.
- The batteries are exhausted.
  - ⇒ Replace the 2 or 4 alkaline batteries, or recharge the rechargeable batteries.
- The disc is placed upside down.
  - ⇒ Place the disc with the labeled side up.
- Condensation has occurred inside the unit.
  - ⇒ Leave the unit for about 1 hour before re-use.
- The AC adaptor is disconnected.
  - ⇒ Connect it properly.

**No sound is heard from the headphones.**

- The headphones are connected incompletely.
  - ⇒ Insert the plug securely into the **PHONE** jack.
- The headphones are connected to **LINE OUT** jack.
  - ⇒ Insert the plug securely into the **PHONE** jack.
- The volume is set to the minimum position on the unit.
  - ⇒ Adjust the volume on the unit.

**Sound skips, or is interrupted.**

- A strong vibration that exceeds the capacity of the ASP has occurred.
  - ⇒ Place the unit in a place not subject to vibration.
- The disc is dirty.
  - ⇒ Clean it.
- The headphone plug is dirty.
  - ⇒ Clean it.

**Noise interferes**

- The headphone plug is dirty.
  - ⇒ Clean it.
- The batteries are low.
  - ⇒ Replace or recharge the batteries.
- The headphones are connected incompletely.
  - ⇒ Insert the plug securely into the **PHONE** jack.
- A source of strong magnetism or radio wave, such as a TV set or cellular phone, is present near the unit.
  - ⇒ Install the unit away from a TV set, cellular phone, etc.

**Rechargeable batteries cannot be recharged.**

- Commercially available rechargeable batteries are used.
  - ⇒ Use the exclusive rechargeable batteries (NB-3A70).

**Note:**

1. This system uses a microcomputer so it may malfunction due to external noise or interference. In such a case, unplug the power cord and remove the batteries, then re-connect the power cord and insert the batteries again.
2. Erroneous operation may occur when the headphone plug is plugged or unplugged; but this is not a malfunction.